

Paul Neuhaus

Paul Neuhaus GmbH  
Olakenweg 36 · 59457 Werl  
Germany

Telefon: +49 (0) 29 22-97 21-0  
Telefax: +49 (0) 29 22-97 21-9120  
E-mail: info@neuhaus-group.de  
<https://scm.paul-neuhaus.de/public/conformity/>



D | Montageanleitung • GB | Fitting instructions





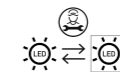
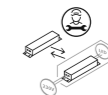

- DE** Dieses Produkt enthält Lichtquellen der Energieeffizienzklasse <E>.
- GB** This product contains light sources of energy efficiency class <E>.
- FR** Ce produit comprend sources lumineuses de classe d'efficience énergétique <E>.
- BG** Продуктът съдържа източници на светлина с клас на енергийна ефективност <E>.
- CZ** Tento výrobek obsahuje světelné zdroje třídy energetické účinnosti <E>.
- DK** Dette produkt indeholder lyskilder af energieeffektklasse <E>.
- EL** Αυτό το προϊόν περιέχει πηγές φωτός της τάξης ενεργειακής απόδοσης <E>.
- ES** Este producto contiene fuentes de luz de la clase de eficiencia energética <E>.
- ET** See toode sisaldab valgusallikad energiatõhusklassiga <E>.
- FI** Tämä tuote sisältää energiatehokkuusluokan <E> valonlähteet.
- HR** Ovaj proizvod sadrži izvori svjetlosti energetskeg razreda <E>.
- HU** Ez a termék <E> energiahatékonysági osztályba tartozó fényforrások tartalmaz.
- IT** Questo prodotto contiene sorgenti luminose della classe di efficienza energetica <E>.
- LT** Šis produktas yra su šviesos šaltiniai, kurio energinio efektyvumo klasė yra <E>.
- LV** Šis izstrādājums satur gaismas avoti, kas atbilst energoefektivitātes klasei <E>.
- NL** Dit product bevat lichtbronnen van energie-efficiëntieklasse <E>.
- NO** Dette produktet inneholder lyskilder i energieffektivitetsklasse <E>.
- PL** Produkt ten zawiera źródła światła o klasie efektywności energetycznej <E>.
- PT** Este produto contém fontes de luz da classe de eficiência energética <E>.
- RO** Acest produs conține surse de lumină din clasa de eficiență energetică <E>.
- RU** Данное изделие содержит источники света класса энергоэффективности <E>.
- SK** Tento výrobek obsahuje svetelné zdroje triedy energetickej efektivity <E>.
- SL** Ta izdelek vsebuje viri svetlobe razreda energijske učinkovitosti <E>.
- SR** Ovaj proizvod sadrži izvori svjetlosti energetske klase <E>.
- SV** Denna produkt innehåller ljuskällor i energieffektivitetsklass <E>.
- TR** Bu ürün, enerji verimliliği sınıfına sahip ışık kaynakları içerir <E>.

833354

230V/50Hz~  
1x LED-Board 24V DC/17 W  
1x LED-Board 24V DC/20 W  
nicht wechselbar / not changeable

 2,4 GHz  
10 dBm



	17W / 20 W 2.040lm / 2.400 lm
	42 W 2.200 lm
	LED-Board
<b>t</b>	25.000 h
<b>Tk</b>	2.700 - 5.000 K
	15.000 x
	<0,5 s
	dimmmable with rrc

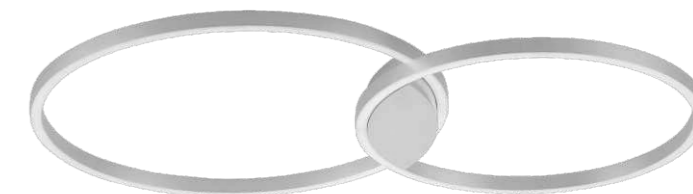

## 1 | Montage / fitting

als Deckenleuchte  
as ceiling light

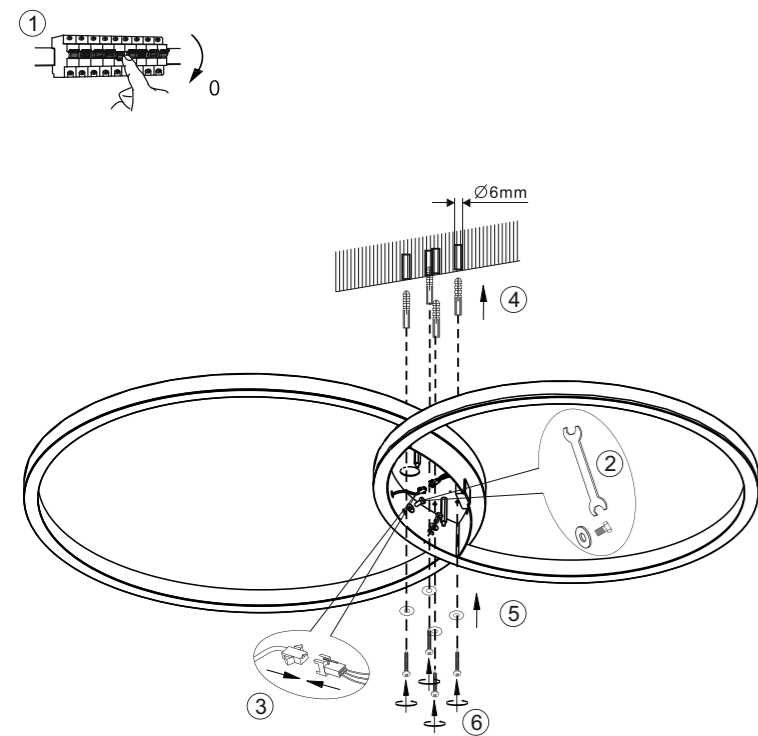

## 2 | Elektrischer Anschluss / electrical connection

230 Volt/50 Hz-Anschluss  
230 voltage/50 Hz connection

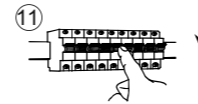
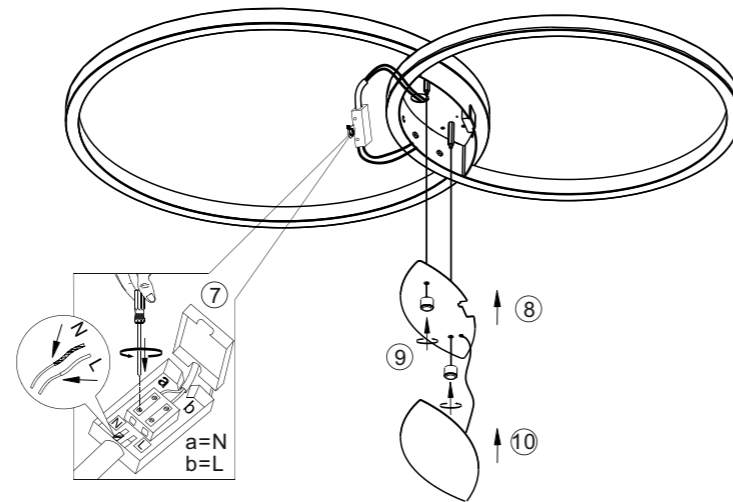

## 3 | Fernbedienung anlernen / teach remote control

Siehe Q-Fernbedienungsanleitung  
See Q-remote control manual

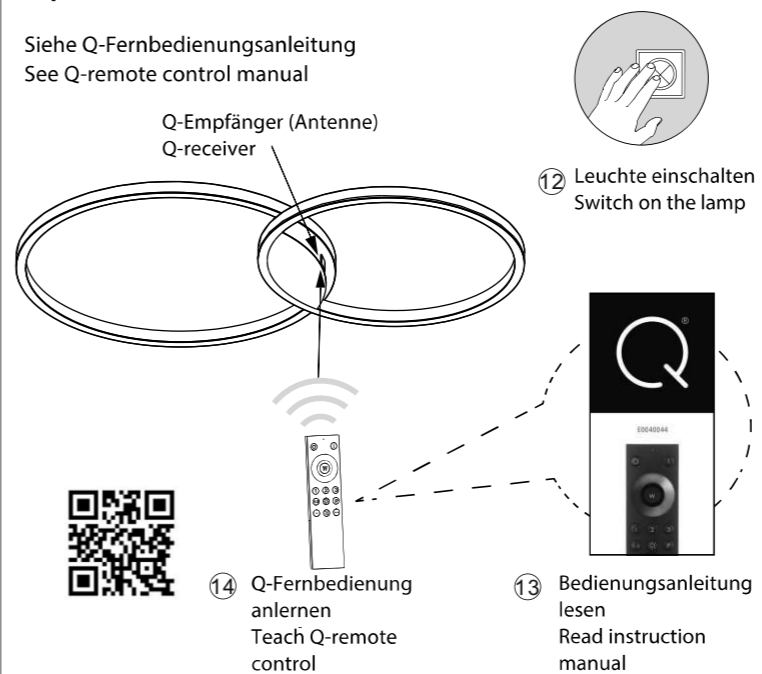

### ⚠ Reset

Rückstellen der Leuchte auf Werkseinstellung  
Reset the lamp, factory new

