



SMART  
HOME  
LIGHTS

D | Montageanleitung · GB | Fitting instructions

# 832469

230V / 50Hz~  
2x 18W LED-Board  
nicht wechselbar / not changeable

 2,4 GHz  
10 dBm

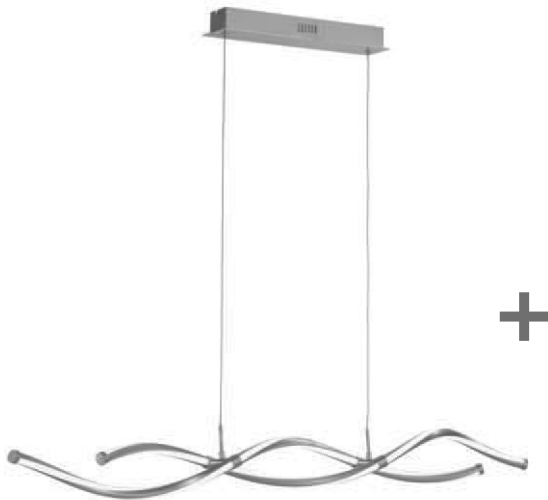

AAA, 1,5V

inkl. Funkfernbedienung  
incl. radio remote control



18 W  
2.250 lm



47 W  
1.650 lm



LED-Board



t 25.000 h



T<sub>k</sub> 2.700-5.000 K



15.000 x



<0,5 s



dimmmable with rrc



# 1 | Montage / fitting

als Pendelleuchte  
as pendant light

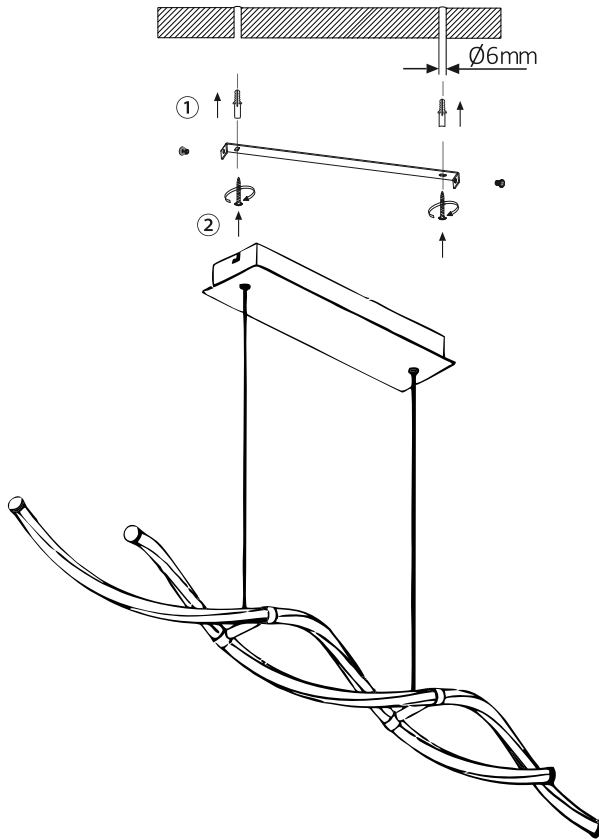

## 2 | Elektrischer Anschluss / electrical connection

230 Volt / 50Hz-Anschluss

230 voltage / 50Hz connection

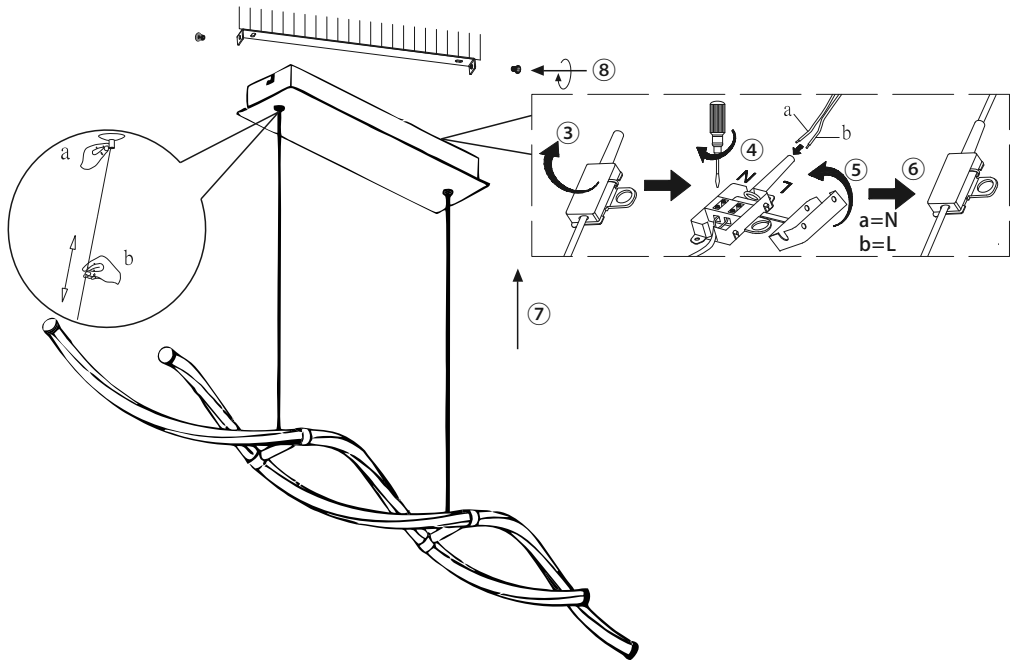

### 3 | Fernbedienung anlernen / teach remote control

Siehe Q-Fernbedienungsanleitung  
See Q-remote control manual

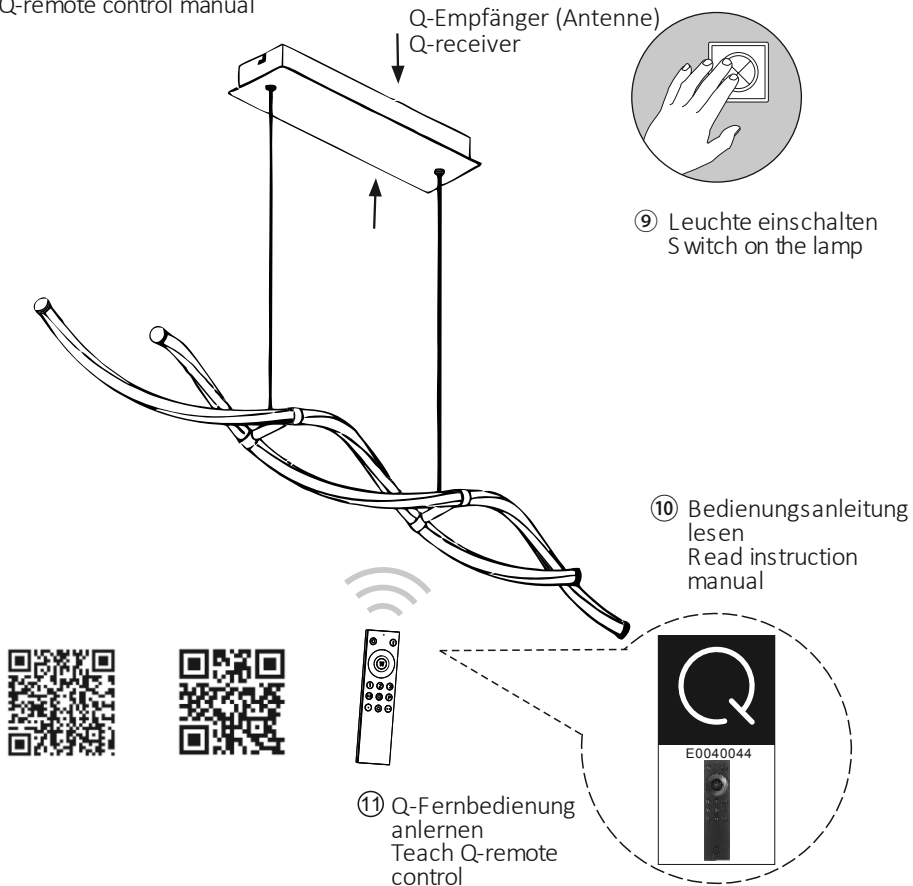

## Reset

Rückstellen der Leuchte auf Werkseinstellung  
Reset the lamp, factory new

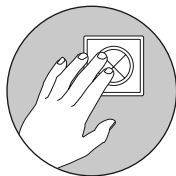

5 x on/off

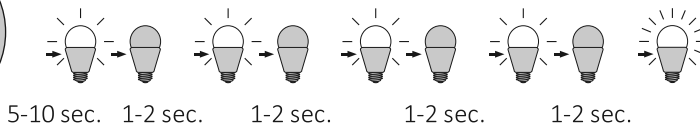

Das Gerät erfüllt die grundlegenden Anforderungen der Richtlinie 2014/53/EU (Radio Equipment Directive) des Europäischen Parlaments und des Rates der europäischen Union vom 16.04.2014 über Funkanlagen. Die vollständige Konformitätserklärung kann bei der unten stehenden Internet-Adresse aufgerufen werden.

This device fulfils the fundamental requirements of Directive 2014/53/EU (Radio Equipment Directive) of the European Parliament and of the Council of the European Union dated 16.04.2014 on items of radio equipment.

The full declaration of conformity can be accessed at the Internet-address given below.

---

*Paul Neuhaus*

Paul Neuhaus GmbH  
Olakenweg 36 · 59457 Werl  
Germany  
Telefon: +49(0) 2922-9721-0  
Telefax: +49(0) 2922-9721-9120  
E-Mail: [Kundenservice@neuhaus.group.de](mailto:Kundenservice@neuhaus.group.de)  
<https://scm.paul-neuhaus.de/public/conformity/>