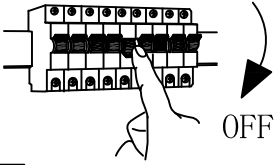
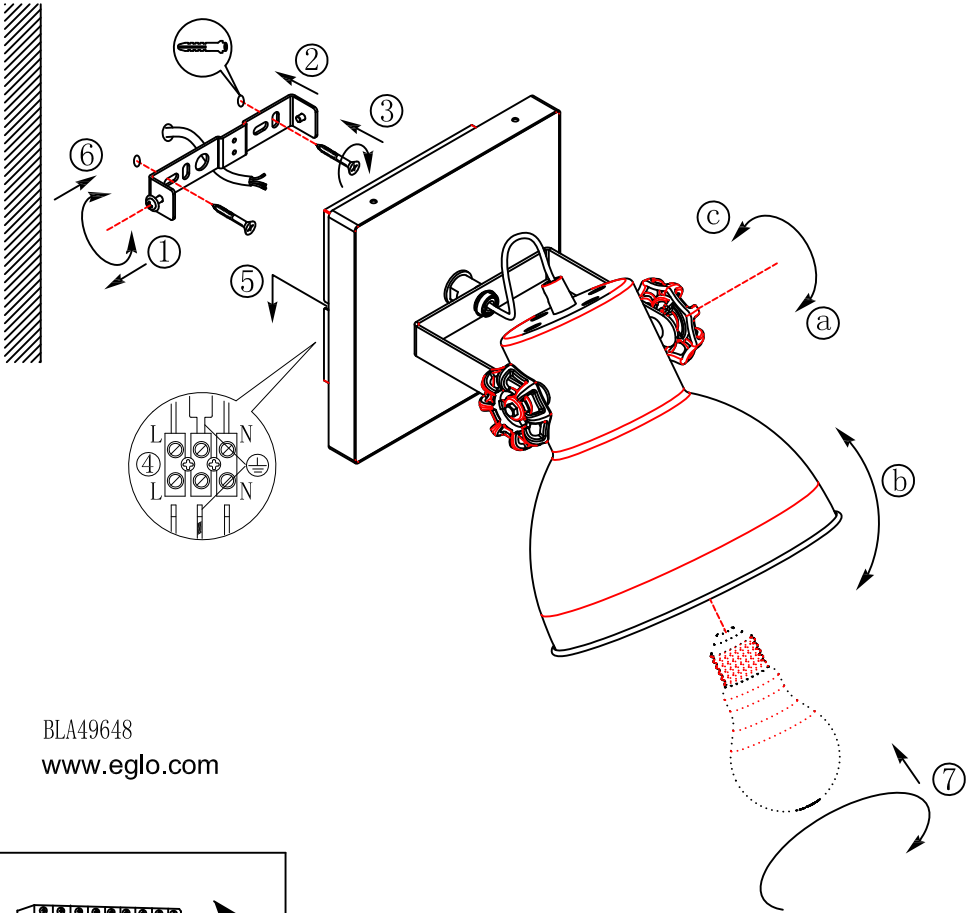

**B****A**

BLA49648  
www.eglo.com

**C**