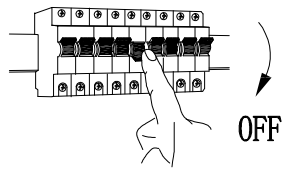
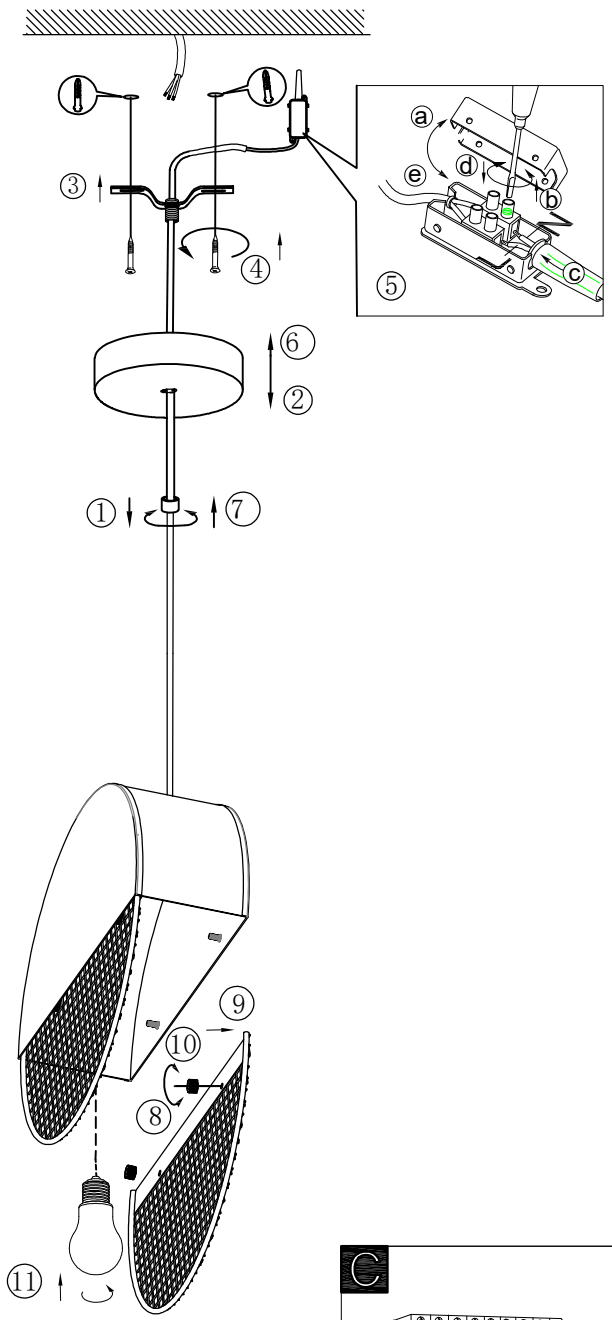
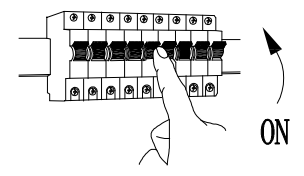

A**B****C**

B43811
www.eglo.com