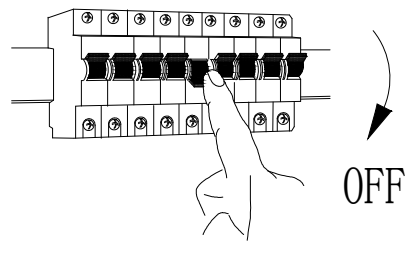
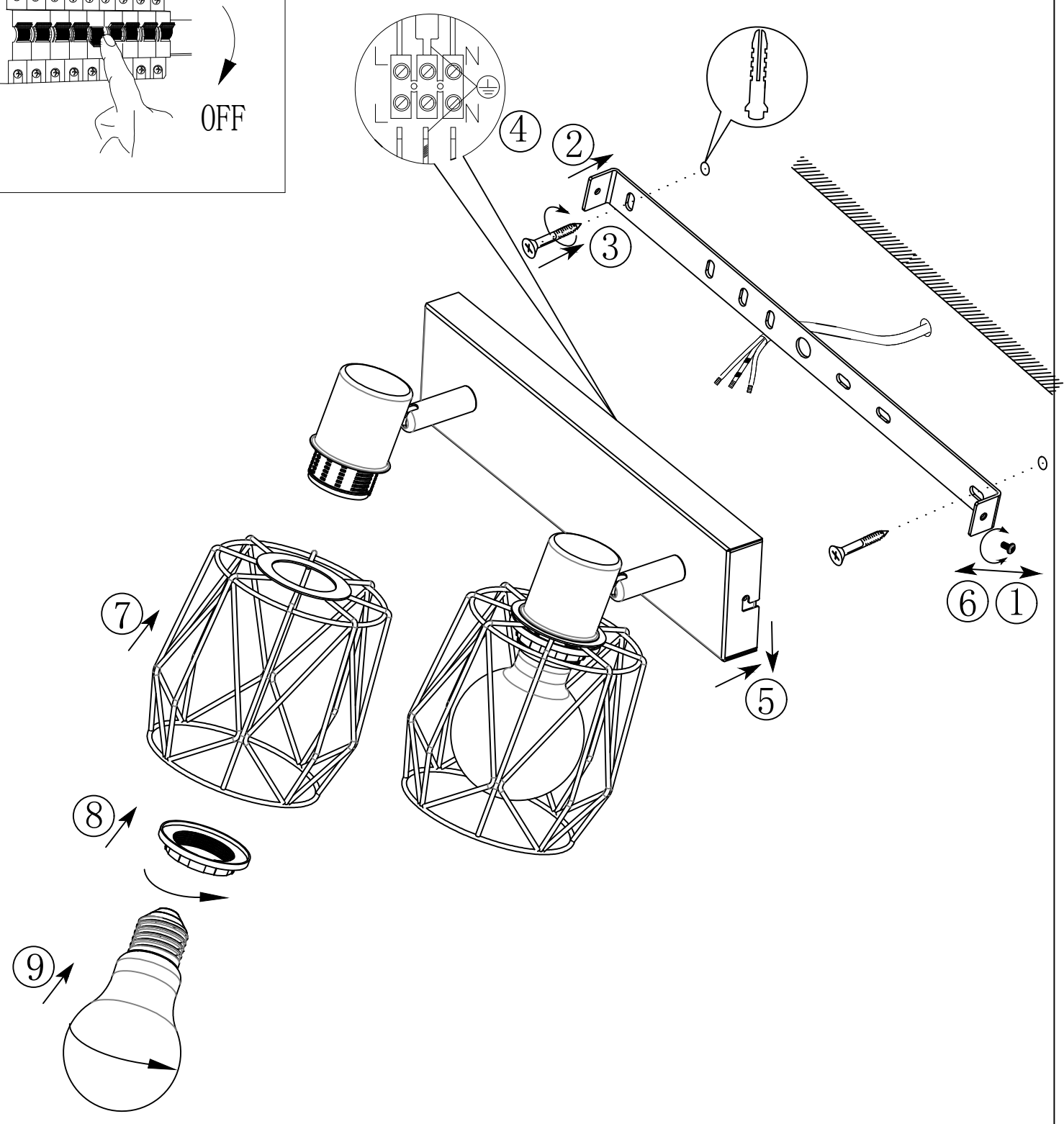
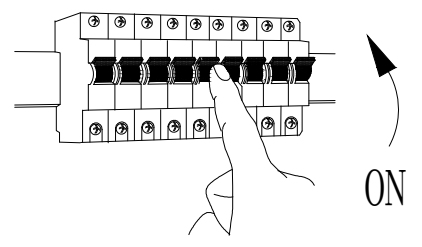

**A****B****C**

BLA390043  
www.eglo.com