

# DISPLAY

DISPLAY WIDE



← 32 →

DISPLAY ACCENT



← 32 →

DISPLAY UGR



← 32 →



28W	3000 K	BIANCO	283524
28W	3000 K	NERO	276267
28W	4000 K	BIANCO	283531
28W	4000 K	NERO	283548
40W	3000 K	BIANCO	283555
40W	3000 K	NERO	283562
40W	4000 K	BIANCO	283579
40W	4000 K	NERO	283586
14W	3000 K	BIANCO	283593
14W	3000 K	NERO	283609
14W	4000 K	BIANCO	283616
14W	4000 K	NERO	283623
27W	3000 K	BIANCO	283647
27W	3000 K	NERO	283630
27W	4000 K	BIANCO	276281
27W	4000 K	NERO	283258
40W	3000 K	BIANCO	283654
40W	3000 K	NERO	283067
40W	4000 K	BIANCO	283661
40W	4000 K	NERO	283678
14W	3000 K	BIANCO	283685
14W	3000 K	NERO	283692
14W	4000 K	BIANCO	283708
14W	4000 K	NERO	283715
40W	3000 K	BIANCO	283722
40W	3000 K	NERO	283050
40W	4000 K	BIANCO	283739
40W	4000 K	NERO	283746
21W	3000 K	BIANCO	283753
21W	3000 K	NERO	283760
21W	4000 K	BIANCO	276274
21W	4000 K	NERO	283777

220 - 240 V AC  
50/60 Hz



L'INSTALLAZIONE DI QUESTO APPARECCHIO DEVE ESSERE EFFETTUATA DA PERSONALE QUALIFICATO  
THE LIGHTING FITTING SHOULD BE INSTALLED BY A QUALIFIED ELECTRICIAN



1

Inserire il dispositivo nel profilo come illustrato.  
Plug the device into the track as illustrated.



2

Attenzione, accertarsi del corretto posizionamento dell'articolo durante l'installazione come illustrato nell'immagine.  
Warning, make sure to install the item in the correct position as illustrated.

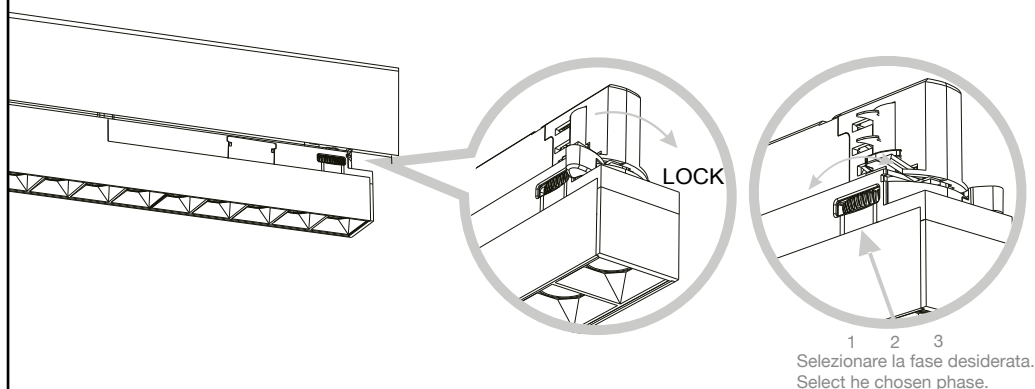

3

Ruotare la leva dei connettori di 90° come illustrato e bloccare il faretto. Selezionare la fase desiderata.  
Turn the connectors' lever 90° according to the illustrated direction and lock the light. Select the chosen phase.

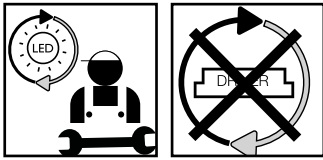

**Questo prodotto contiene una sorgente luminosa  
 di classe di efficienza energetica /  
 This product is provided with a light source  
 with efficiency energy class of:**

<b>EAN</b>	<b>Modello Sorgente Luminosa /Light Source Model</b>	<b>Classe di Efficienza Energetica / Energy Efficiency Class</b>	<b>Sorgente Luminosa / Light Source (mA)</b>	<b>Sorgente Luminosa / Light Source (V)</b>
8021696283609	DISPLAY ACCENT D0535 3000K	D	350 mA	35 V DC
8021696283593	DISPLAY ACCENT D0535 3000K	D	350 mA	35 V DC
8021696283623	DISPLAY ACCENT D0535 4000K	D	350 mA	35 V DC
8021696283616	DISPLAY ACCENT D0535 4000K	D	350 mA	35 V DC
8021696276267	DISPLAY ACCENT D1065 3000K	D	700 mA	35 V DC
8021696283524	DISPLAY ACCENT D1065 3000K	D	700 mA	35 V DC
8021696283548	DISPLAY ACCENT D1065 4000K	D	700 mA	35 V DC
8021696283531	DISPLAY ACCENT D1065 4000K	D	700 mA	35 V DC
8021696283562	DISPLAY ACCENT D1595 3000K	D	1050 mA	35 V DC
8021696283555	DISPLAY ACCENT D1595 3000K	D	1050 mA	35 V DC
8021696283586	DISPLAY ACCENT D1595 4000K	D	1050 mA	35 V DC
8021696283579	DISPLAY ACCENT D1595 4000K	D	1050 mA	35 V DC
8021696283692	DISPLAY UGR D0535 3000K	C	350 mA	35 V DC
8021696283685	DISPLAY UGR D0535 3000K	C	350 mA	35 V DC
8021696283715	DISPLAY UGR D0535 4000K	C	350 mA	35 V DC
8021696283708	DISPLAY UGR D0535 4000K	C	350 mA	35 V DC
8021696283258	DISPLAY UGR D1065 4000K	C	700 mA	35 V DC
8021696276281	DISPLAY UGR D1065 4000K	C	700 mA	35 V DC
8021696283067	DISPLAY UGR D1595 3000K	C	1050 mA	35 V DC
8021696283654	DISPLAY UGR D1595 3000K	C	1050 mA	35 V DC
8021696283678	DISPLAY UGR D1595 4000K	C	1050 mA	35 V DC
8021696283661	DISPLAY UGR D1595 4000K	C	1050 mA	35 V DC

8021696283760	DISPLAY WIDE D0565 3000K	C	500 mA	35 V DC
8021696283753	DISPLAY WIDE D0565 3000K	C	500 mA	35 V DC
8021696283777	DISPLAY WIDE D0565 4000K	C	500 mA	35 V DC
8021696276274	DISPLAY WIDE D0565 4000K	C	500 mA	35 V DC
8021696283050	DISPLAY WIDE D1125 3000K	D	1050 mA	35 V DC
8021696283722	DISPLAY WIDE D1125 3000K	D	1050 mA	35 V DC
8021696283746	DISPLAY WIDE D1125 4000K	D	1050 mA	35 V DC
8021696283739	DISPLAY WIDE D1125 4000K	D	1050 mA	35 V DC
8021696283630	DISPLAY UGR D1065 3000K	C	700 mA	35 V DC
8021696283647	DISPLAY UGR D1065 3000K	C	700 mA	35 V DC

## LEGENDA ICONE

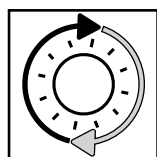

Sorgente luminosa sostituibile dall'utente finale.  
Replaceable light source by an end-user.

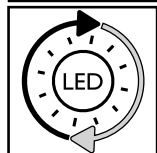

Sorgente LED luminosa sostituibile dall'utente finale.  
Replaceable LED light source by an end-user.

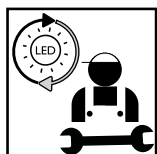

Sorgente luminosa sostituibile esclusivamente da personale autorizzato.  
Replaceable light source by authorized personnel only.

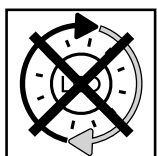

Sorgente luminosa non sostituibile. Quando la sorgente arriverà a fine vita dovrà essere sostituito l'intero apparecchio.  
Non-replaceable light source. Upon end of life of the light source, the whole product will be replaced.

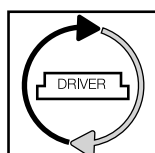

Dispositivo di alimentazione sostituibile dall'utente finale.  
Replaceable control gear by an end-user.

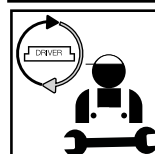

Dispositivo di alimentazione sostituibile esclusivamente da personale autorizzato.  
Replaceable light source by authorized personnel only.

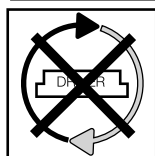

Dispositivo di alimentazione non sostituibile. Quando il dispositivo di alimentazione arriverà a fine vita dovrà essere sostituito l'intero apparecchio.  
Upon end of life of the control gear, the whole product will be replaced.











- 18.** Jei apsauginis stiklas yra įskilęs arba sudužęs, pakeiskite jį nedelsiant ir naudodami tik nuostatus atitinkančias keičiamas dalis.
- 19.** Šviesos šaltinis su nekeičiamais šviesos diodais (LED). Neišmontuokite gaminio, nes diodai gali pažeisti akis. Nejmerkite į vandenį. Valykite naudodami drėgną šluostę ir venkite stiprių tirpiklių ir ploviklių naudojimo.
- 20.** Prietaise įdiegtas lydysis saugiklis. Jei šviestuvą neįsijungia, pakeiskite lydijį saugiklį.
- 21.** I-ą elektros saugos klasę užtikrina bendra izoliacija bei apsauginis laidininkas (žeminimas) prijungtas prie metalinės šviestuvo dalies. Privalomas žeminimas
- 22.** II-ą elektros saugos klasę užtikrina bendra izoliacija ir dviguba izoliacija arba sustiprinta izoliacija. Žeminimas nėra būtinas.
- 23.** III-ą elektros saugos klasę užtikrina labai žemos įtampos maitinimas (mažesnis, nei 50 voltų). Žeminimas nėra būtinas.
- 24.** Neapsaugotas.
- 25.** Apsaugotas nuo kietųjų kūnų, kurių skersmuo didesnis, nei 50 mm. patekimo.
- 26.** Apsaugotas nuo kietųjų kūnų, kurių skersmuo didesnis, nei 12 mm. patekimo.
- 27.** Apsaugotas nuo kietųjų kūnų, kurių skersmuo didesnis, nei 2,5 mm. patekimo.
- 28.** Apsaugotas nuo kietųjų kūnų, kurių skersmuo didesnis, nei 1 mm. patekimo.
- 29.** Apsaugotas nuo dulkių patekimo.
- 30.** Visiškai apsaugotas nuo dulkių patekimo.
- 31.** Neapsaugotas.
- 32.** Apsaugotas nuo statmenai krentančių vandens lašų patekimo.
- 33.** Apsaugotas nuo vandens lašų, kurių kritimo didžiausias kampas yra 15°, patekimo.
- 34.** Apsaugotas nuo lietaus.
- 35.** Apsaugotas nuo vandens pūslių.
- 36.** Apsaugotas nuo vandens čiurkšlių.
- 37.** Apsaugotas nuo stiprių vandens čiurkšlių.
- 38.** Apsaugotas nuo laikino įmerkimo.
- 39.** Apsaugotas nuo įmerkimo tam tikram laikui.
- 40.** Prietaisas neturi būti uždengiamas šilumą izoliuojančia medžiaga.
- 41.** Dėmesio, elektros smūgio pavojus.
- 42.** Nežiūrėkite tiesiai į šviesos šaltinį.