

GAME TRIM ROUND

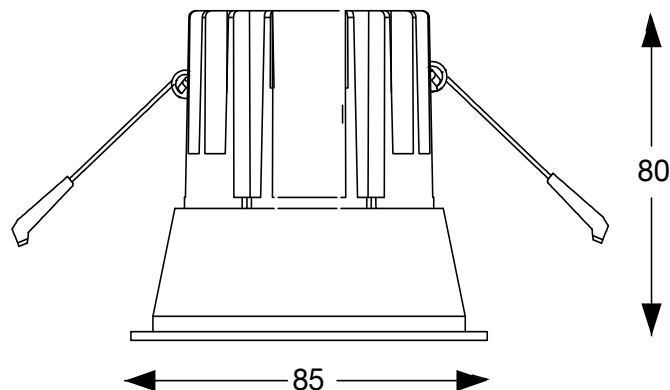

11W
11W
11W
11W
11W
11W
11W
11W
11W
11W
11W
11W
11W
11W



3000 K
3000 K
3000 K
3000 K
3000 K
3000 K
3000 K
3000 K
4000 K
4000 K
2700 K
2700 K

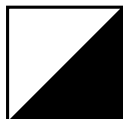

WH+BLACK
WH+GOLD
WH+SILVER
WH+WHITE
BK+BLACK
BK+GOLD
BK+SILVER
BK+WHITE
BK+BLACK
WH+WHITE
BK+BLACK
WH+WHITE



192277
192307
192284
192291
192314
192345
192321
192338
267968
267975
285412
285429



Front



Rear



220 - 240 V AC
50/60 Hz

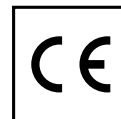

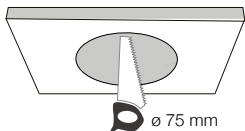
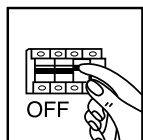

1

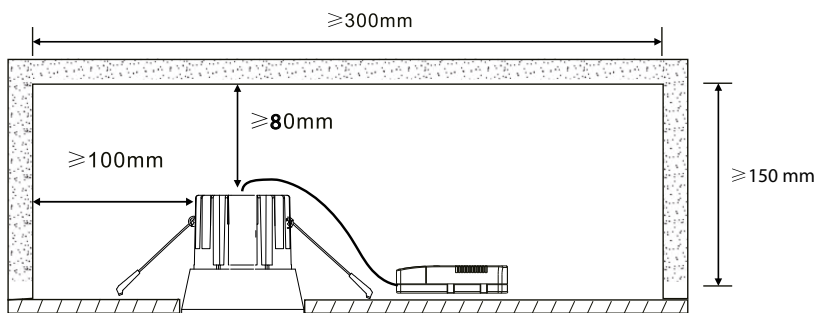
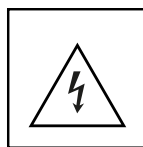

Praticare un foro al soffitto con la misura indicata. Attenzione, rispettare gli spazi d'installazione come da illustrazione.
Drill a hole into the ceiling with the above dimensions. Attention, respect the installation spaces as illustrated.

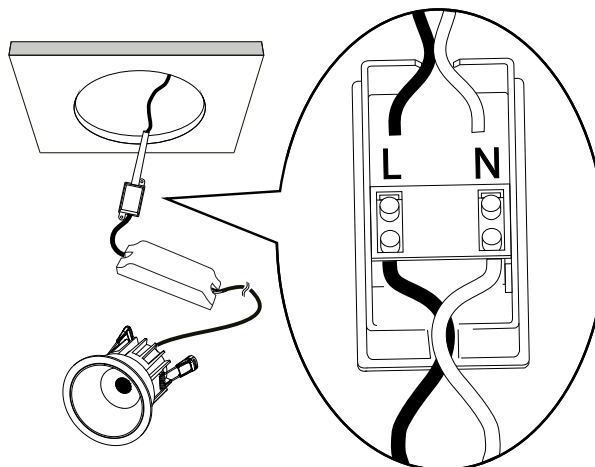

2

Connettere la morsettera ai propri cavi come indicato.
Connect the terminal box to your own electric wires as indicated.

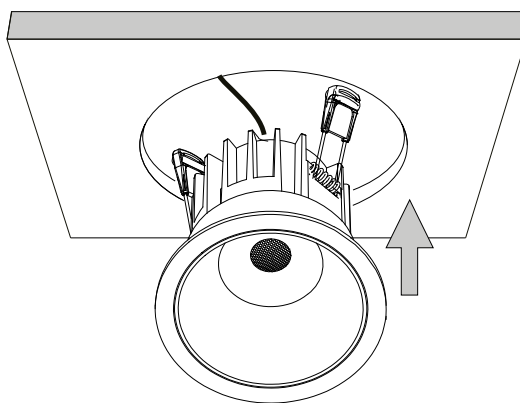

3

Inserire il faretto nel foro sollevando le molle laterali.
Insert the spotlight into the hole by lifting the side springs.

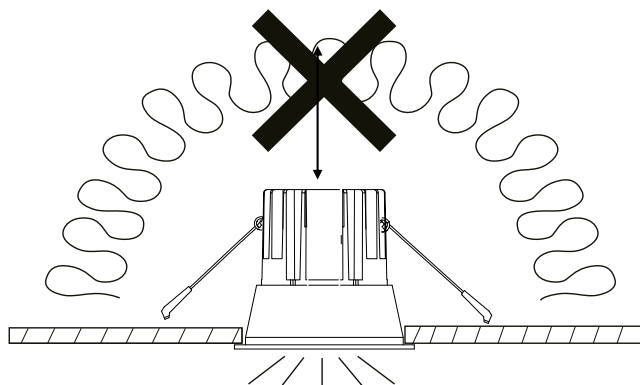

4

Attenzione! Apparecchio non idoneo ad essere ricoperto di materiale termicamente isolante.
Warning! Luminaire not suitable for covering with thermally insulating material.

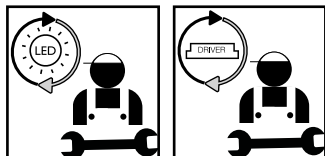

Questo prodotto contiene una sorgente luminosa di classe di efficienza energetica / This product is provided with a light source with efficiency energy class of:

EAN	Modello Sorgente Luminosa /Light Source Model	Classe di Efficienza Energetica / Energy Efficiency Class	Sorgente Luminosa / Light Source (mA)	Sorgente Luminosa / Light Source (V)
8021696285412	GAME 11W SOURCE 2700K B	G	250 mA	36 V DC
8021696285429	GAME 11W SOURCE 2700K B	G	250 mA	36 V DC
8021696192314	GAME 11W SOURCE 3000K B	G	250 mA	36 V DC
8021696192345	GAME 11W SOURCE 3000K B	G	250 mA	36 V DC
8021696192321	GAME 11W SOURCE 3000K B	G	250 mA	36 V DC
8021696192338	GAME 11W SOURCE 3000K B	G	250 mA	36 V DC
8021696192277	GAME 11W SOURCE 3000K B	G	250 mA	36 V DC
8021696192307	GAME 11W SOURCE 3000K B	G	250 mA	36 V DC
8021696192284	GAME 11W SOURCE 3000K B	G	250 mA	36 V DC
8021696192291	GAME 11W SOURCE 3000K B	G	250 mA	36 V DC
8021696267968	GAME 11W SOURCE 4000K B	F	250 mA	36 V DC
8021696267975	GAME 11W SOURCE 4000K B	F	250 mA	36 V DC

LEGENDA ICONE

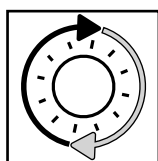

Sorgente luminosa sostituibile dall'utente finale.
 Replaceable light source by an end-user.

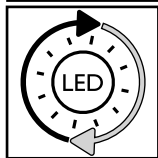

Sorgente LED luminosa sostituibile dall'utente finale.
 Replaceable LED light source by an end-user.

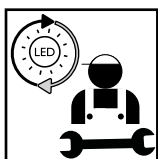

Sorgente luminosa sostituibile esclusivamente da personale autorizzato.
 Replaceable light source by authorized personnel only.

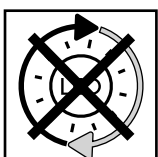

Sorgente luminosa non sostituibile. Quando la sorgente arriverà a fine vita dovrà essere sostituito l'intero apparecchio.
 Non-replaceable light source. Upon end of life of the light source, the whole product will be replaced.

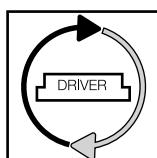

Dispositivo di alimentazione sostituibile dall'utente finale.
 Replaceable control gear by an end-user.

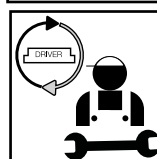

Dispositivo di alimentazione sostituibile esclusivamente da personale autorizzato.
 Replaceable light source by authorized personnel only.

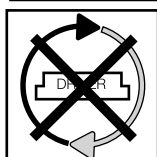

Dispositivo di alimentazione non sostituibile. Quando il dispositivo di alimentazione arriverà a fine vita dovrà essere sostituito l'intero apparecchio.
 Upon end of life of the control gear, the whole product will be replaced.

- 18.** Jei apsauginis stiklas yra įskilęs arba sudužęs, pakeiskite jį nedelsiant ir naudodami tik nuostatus atitinkančias keičiamas dalis.
- 19.** Šviesos šaltinis su nekeičiamais šviesos diodais (LED). Neišmontuokite gaminio, nes diodai gali pažeisti akis. Nejmerkite į vandenį. Valykite naudodami drėgną šluostę ir venkite stiprių tirpiklių ir ploviklių naudojimo.
- 20.** Prietaise įdiegtas lydysis saugiklis. Jei šviestuvą neįsijungia, pakeiskite lydijį saugiklį.
- 21.** I-ą elektros saugos klasę užtikrina bendra izoliacija bei apsauginis laidininkas (žeminimas) prijungtas prie metalinės šviestuvo dalies. Privalomas žeminimas
- 22.** II-ą elektros saugos klasę užtikrina bendra izoliacija ir dviguba izoliacija arba sustiprinta izoliacija. Žeminimas nėra būtinas.
- 23.** III-ą elektros saugos klasę užtikrina labai žemos įtampos maitinimas (mažesnis, nei 50 voltų). Žeminimas nėra būtinas.
- 24.** Neapsaugotas.
- 25.** Apsaugotas nuo kietųjų kūnų, kurių skersmuo didesnis, nei 50 mm. patekimo.
- 26.** Apsaugotas nuo kietųjų kūnų, kurių skersmuo didesnis, nei 12 mm. patekimo.
- 27.** Apsaugotas nuo kietųjų kūnų, kurių skersmuo didesnis, nei 2,5 mm. patekimo.
- 28.** Apsaugotas nuo kietųjų kūnų, kurių skersmuo didesnis, nei 1 mm. patekimo.
- 29.** Apsaugotas nuo dulkių patekimo.
- 30.** Visiškai apsaugotas nuo dulkių patekimo.
- 31.** Neapsaugotas.
- 32.** Apsaugotas nuo statmenai krentančių vandens lašų patekimo.
- 33.** Apsaugotas nuo vandens lašų, kurių kritimo didžiausias kampas yra 15°, patekimo.
- 34.** Apsaugotas nuo lietaus.
- 35.** Apsaugotas nuo vandens pūslių.
- 36.** Apsaugotas nuo vandens čiurkšlių.
- 37.** Apsaugotas nuo stiprių vandens čiurkšlių.
- 38.** Apsaugotas nuo laikino įmerkimo.
- 39.** Apsaugotas nuo įmerkimo tam tikram laikui.
- 40.** Prietaisas neturi būti uždengiamas šilumą izoliuojančia medžiaga.
- 41.** Dėmesio, elektros smūgio pavojus.
- 42.** Nežiūrėkite tiesiai į šviesos šaltinį.